



TECHNICAL INFORMATION

THE INFLOW OF UNWANTED AIR

CONTROL VALVES CAN HELP SOLVE THE PROBLEM

AIR IN PRESSURIZED PIPES

The main reason for the inflow of air in public water distribution systems is excessive water velocity. Air traveling with water in pressurized pipes can result in high turbulence derived from the dynamic characteristics of each element (compressibility and gravity).

How can high velocity prevent the extraction of air and increase the inflow of air? In order to understand this in a simplified way Fig. 1 to 4 show how air is flowing in the pipe.

In Fig. 1 and 2 water is flowing at an acceptable velocity of maximum 2 m/s. At this velocity extraction of air with automatic air valves is easy.

Fig. 3 shows an increase in velocity of air (air vents open) compared with water velocity. Waves will be formed and extraction of air is more difficult.

At high velocities (Fig. 4) the water tends to have an annular flow. In these cases, extraction of air is impossible and air valve action will be inverted with the inflow of a large volume of air inside the pipeline.

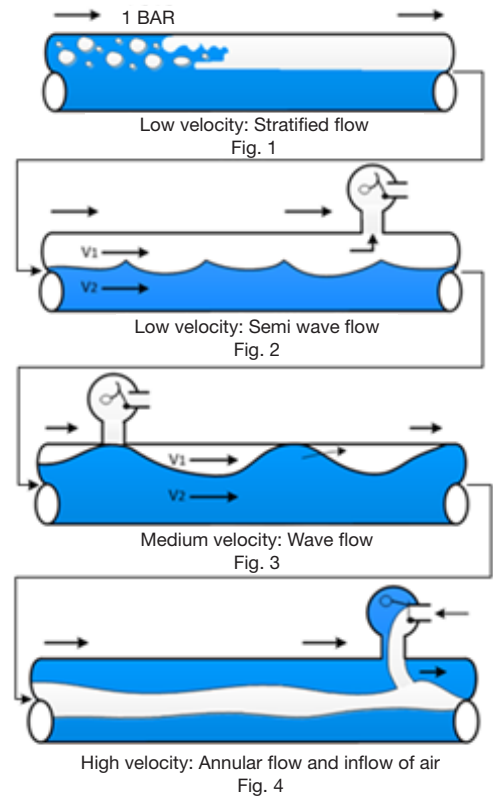

VELOCITY AND INFLOW OF AIR

Large volume of air can be introduced in the pipe system as in the following examples:

Fig. 5 and 6 - Vortex in reduced volume head loss tanks

Fig. 7 - Vortex in a pumping station with reduced tank volume

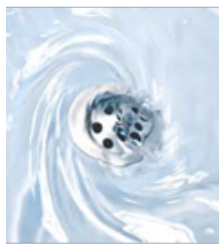

Vortex

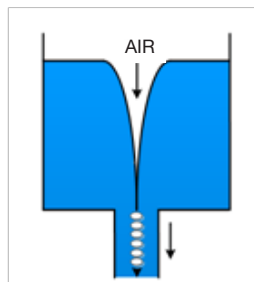

Fig. 5

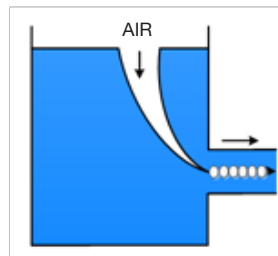

Fig. 6

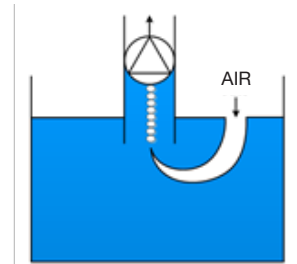

Fig. 7

Fig. 8 - Clogged protection filter or a partially closed valve in the system

Fig. 9 - Micrometric cells of dissolved air will grow in a pressure reducing station

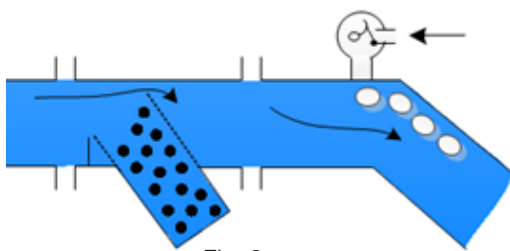

Fig. 8

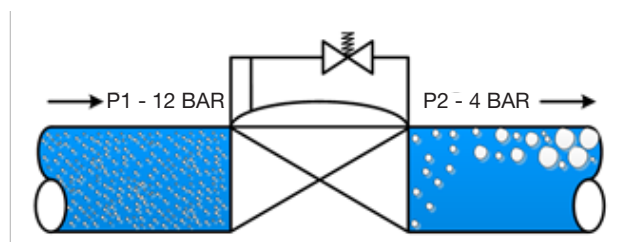

Fig. 9

THE INFLOW OF UNWANTED AIR

CONTROL VALVES CAN HELP SOLVE THE PROBLEM

HOW TO SOLVE THE PROBLEM OF SYSTEM COLLAPSE

- 1) Correctly sized valves with anti-cavitation trim to limit the maximum velocity to 2m/s: Valve size DN80 full bore (Example: Valve C in the system shown in Fig. 10)

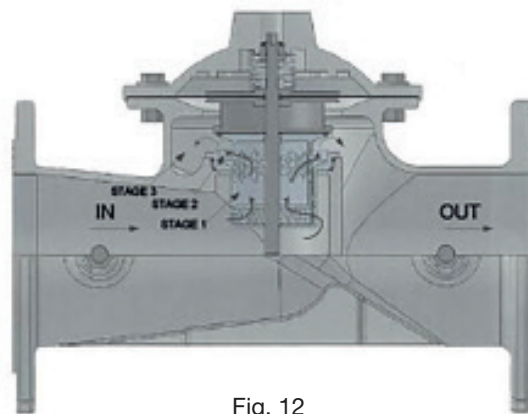
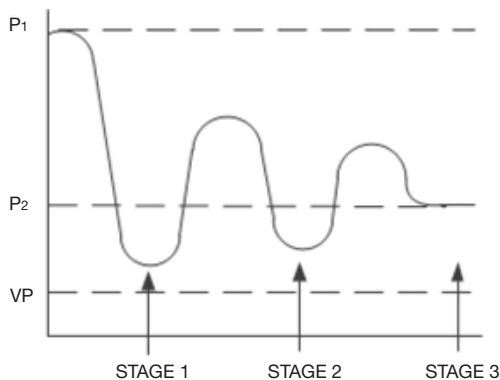

Fig. 12

A combined 3-phase operation

When the valve starts to open, flow converges in the seat cage. The slide plug cylinder opens the perforated slots on the seat cage at the same time as slots with large areas open in the upper part of the slide plug cylinder upstream of the seat. The flow converges on the center of the cylinders and the slots act as a flow divider allowing potential cavitation to dissipate in this first stage.

The upper slots of the sliding cylinder will then again divide the flow and dissipate energy in a second stage preventing flow jets to stick to the body walls downstream of the seat. In the third stage, bubbles collapse with a minimum energy without any cavitation effect and with low noise.

- 2) A correctly sized standard valve with a special pilot system and a correctly sized diffuser to limit the maximum velocity to 2 m/s: Valve size DN80 reduced bore (Example: Valve C in the system shown in Fig. 10)

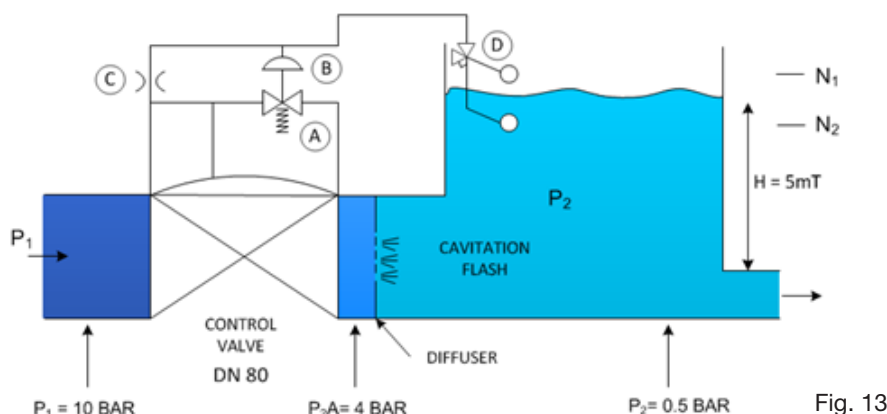

Working conditions:
 P₁: 10 bar
 P₂: 0.5 bar
 Maximum flow rate: 150 m³/h
 A - Pressure reducing pilot
 B - Hydraulic module
 C - 1.5 mm Ø restriction orifice
 D - Float pilot (ON - OFF)

Fig. 13

When the N₂ level is reached, hydraulic module (B) opens pilot (A).

The main valve reduces the pressure to a stable value of 4 bar upstream of the diffuser (pressure reducing pilot set to 4 bar), preventing cavitation inside the valve.

When the N₁ level is reached, hydraulic module (B) closes the main valve.

To increase the maximum flow rate, increase the set pressure of the pilot (B).

To decrease the maximum flow rate, decrease the set pressure of the pilot (B) but maintain the cavitation free values.

THE INFLOW OF UNWANTED AIR

CONTROL VALVES CAN HELP SOLVE THE PROBLEM

VORTICES - PREVENTION

Even at low flow demand, vortices can occur in small volume head loss tanks and pumping stations.

INFLOW OF AIR IN HEAD LOSS TANKS

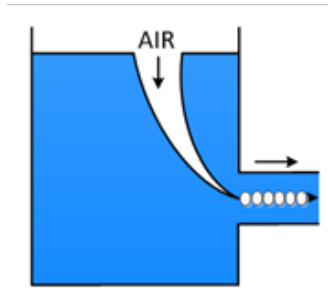
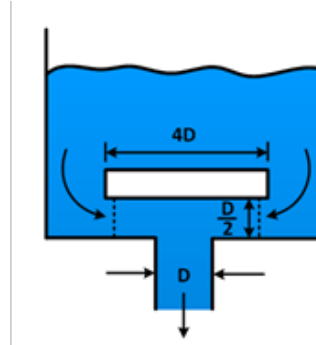

Fig. 14



INFLOW OF AIR IN PUMP STATIONS

The inflow of air caused by the formation of a vortex in a pumping station can be very harmful. Air is a compressible fluid and if the pump stops due to power failure, the risk of water hammer intensity will be increased with the presence of air. High surges will be violent and destructive.

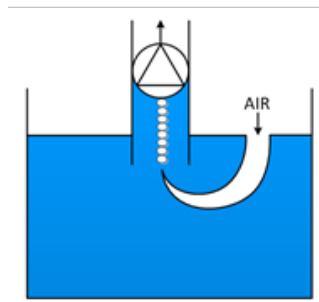
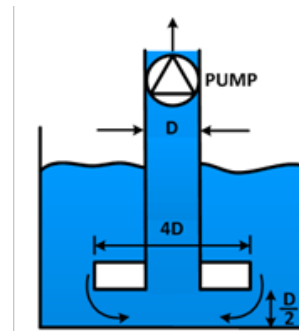

Fig. 15



RUPTURES CAUSED BY PERMANENT AIR POCKETS

Air is an element that may cause structured damage in an installation. In a branch, pipe extensions not in use can work as a pneumatic piston creating increasing and decreasing successive pressure surges causing material fatigue.

At sudden closure of a control valve in a system, P_1 increases compressing the air and absorbing the inherent energy immediately after the compression. The air under pressure acts as a pneumatic cylinder, causing successive hydraulic waves that cause damage in the system structure.

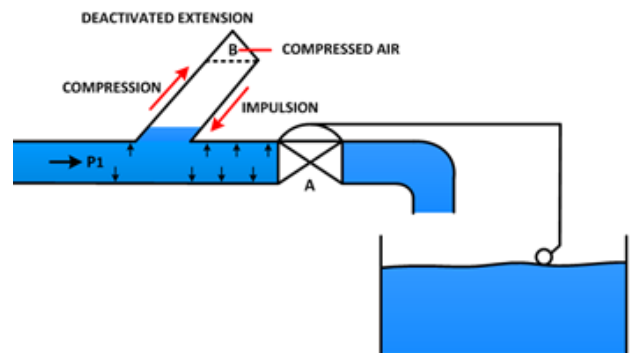

Fig. 16

THE INFLOW OF UNWANTED AIR

CONTROL VALVES CAN HELP SOLVE THE PROBLEM

WATER DISTRIBUTION SYSTEM - CORRECTLY SIZED

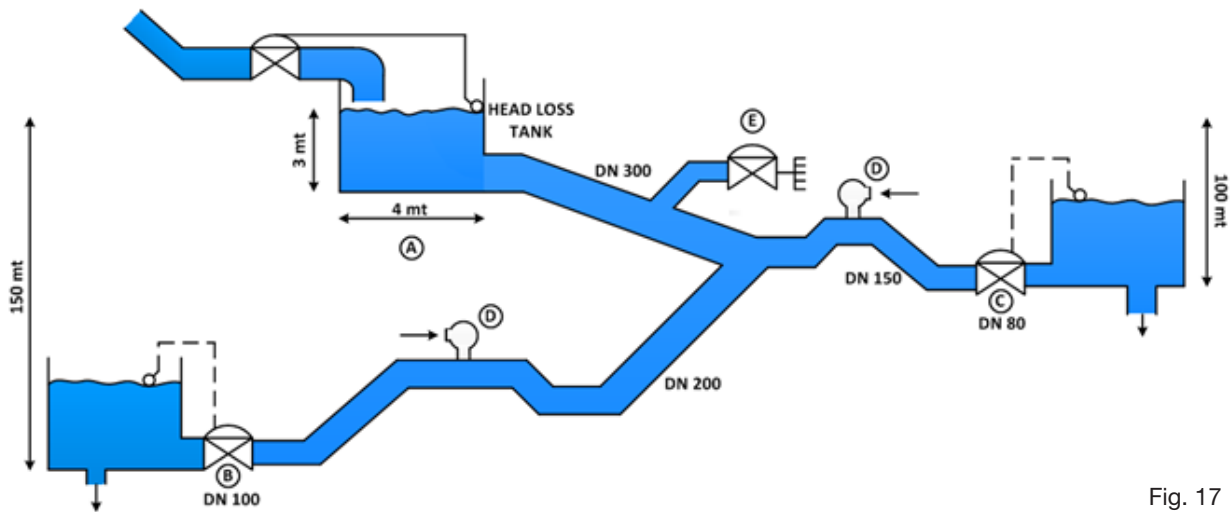

Fig. 17

- A - Upper tank
- B - Control valve
- C - Control valve
- D - Air valves
- E - Pressure reducing valve

CORRECT CHOICE OF VALVES

Modulating float level instead of ON/OFF control valves.

- VALVE C: DN80 full bore with anti-cavitation trim to limit velocity at maximum flow (Fig. 12)
- or:
- DN80 reduced bore standard valve with a correctly sized diffuser to limit velocity and maximum flow (Fig. 13)

VALVE B: Same as valve C but DN100

Both valves have a pressure sustaining function to prevent inlet pressure failure on pressure reducing valve E to ensure system stability (Fig. 18).

The maximum velocity in the system is 2 m/s



Fig. 18
Modulating float/ Pressure sustaining